

KHS80-98W

Features

- * Aluminum housing
- * CE approved
- * Eco-product
- * Extended longer life
- * High luminance
- * Low power consumption
- * RoHS compliant
- * Well heat sink
- * Wide viewing angle

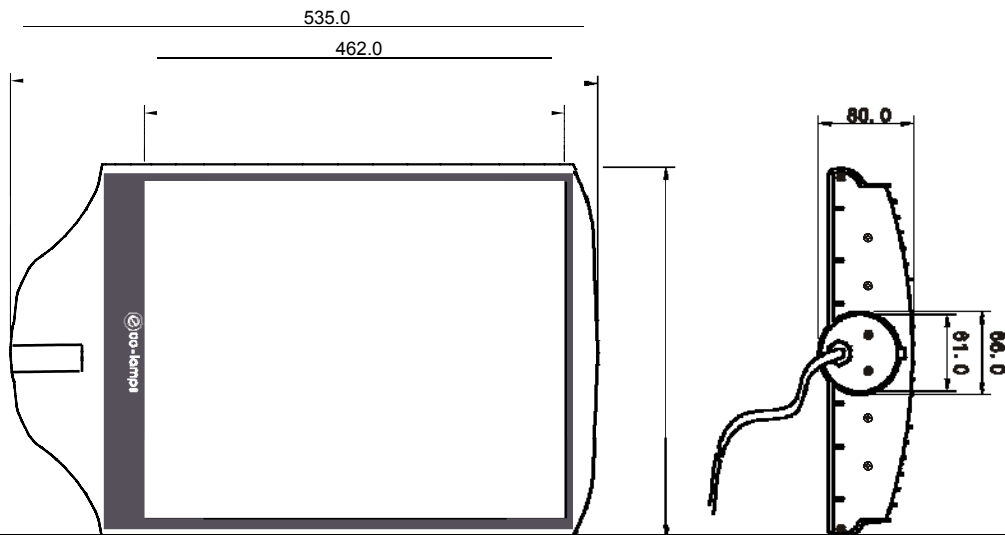

Input Voltage	AC170-250V	
Power Power	98×1W	
System Consumption	111W	
Power Factor	>0.95	
Color Temperature	2500K-10000K	
Working Temperature	-35℃~50℃	
Luminous Flux	7780LM	
Protecting Grade	IP65	
Working Life	>50000 (h)	
Average illumination	Height 6M	>39Lux
	Height 9M	>21Lux
Effective illuminated Area	Height 6M	10×24m ²
	Height 9M	12×30m ²
Chief Material	Aluminum Alloy	
Net Weight	5.6kg	
Packaging Size	615×315×90(mm)	
Installing Size	φ61(mm)	

Important:

- * Bulb electricity is compatible with the light socket voltage.
- * The power is off while plug the light bulb into the socket.
- * Specified performance measured in 170-250V range.
- * Do not look permanently to the light sources.

